

Temperature / Humidity Sensor

USER'S MANUAL

Thank you very much for buying this GRAPHTEC product. This product is a measurement sensor (hereafter "module") that connects to the GL100-N/GL100-WL.

These directions describe preparations and cautions before measurement.

To ensure safety, please read the operation instructions, etc.

For details on the warnings and how to handle this module, please read the Quick Start Guide or USER'S MANUAL included on the CD-ROM (included in the GL100 packaging)

Confirmation of the exterior

After opening the package, please confirm that there are no problems (scratches and dirt) on the exterior before use.

Confirmation of the attached items.

- User's manual (this book): 1

If by any chance faults are found, please contact the store where you bought the item.

Please note that items mentioned in this book may change without prior notice.

1 Part Names

This section describes the name and function of each part.

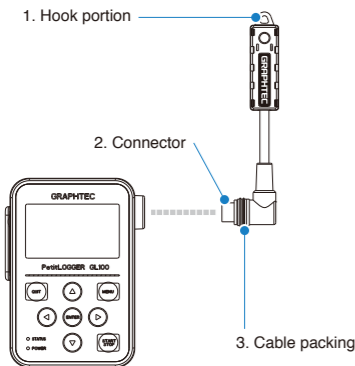

GL100 main module

- 1. Hook portion Used to mount to a wall.
2. Connector Used to connect to the connector on the GL100 module.
3. Cable packing This packing is used when connecting the connector.

CAUTION Attaching just this module to the wall, etc. will damage the connector cable. Always connect to the GL100.

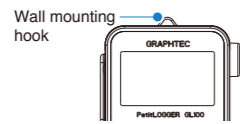

CAUTION The temperature sensor measures the change in capacitance of the conductivity caused by moisture absorption. Therefore, dust, fumes and other organic compound may affect measurements. Usage in an environment with a large quantity of these substances floating about will cause large measurement deviations.

After connecting the GL100 to modules or sensors, please always check/set the time and date.

2 How To Measure

1. Power supply

(Refer to Quick Start Guide or USER'S MANUAL.) Connect this module while power is being supplied to the GL100 by a battery or USB cable.

2. Start-up and operation

(1) Screen display menu flow After power-on, the GL100 is ready for operation by holding down [MENU] key. When the module is connected, "Module Type Recognition" screen is displayed. When the module is not connected, "Module Unconnected State" screen is displayed. Operate in accordance with the displayed instructions.

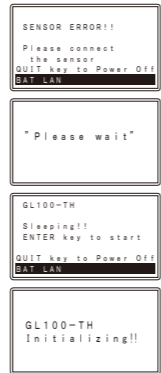

Module unconnected state <Operation> Connect the module.
Recognition of module types
Standby state <Operation> Press [ENTER] key.
Module start-up

(2) Free-running screen

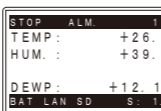

Hold down the [QUIT] key (approx. three seconds) to put the module into standby state. When running on batteries, the module will automatically go into standby state after three minutes of no operation. Press the [ENTER] key while in standby state to return to the free-running screen.

3. Setting

(1) Screen operation

Item selecting screen

Press the [MENU] key on the free-running screen to go to the setting screen. <How to set> Select the item with the directional keys (< > < >) and press the [ENTER] key.

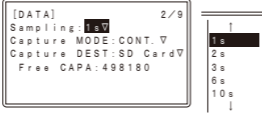

If the submenu shows a down arrow then there are selections in those directions.

Numerical entry screen

<How to set>

Numbers can be inputted by increasing or decreasing the value with the < and > keys.

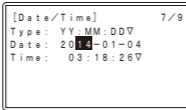

(2) AMP setting

The accumulated temperature can be set for the set temperature.

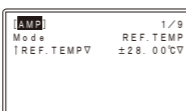

Table for AMP Input setting: Mode, REF. TEMP, Value setting.

(3) DATA setting

Set the Sampling and Capture Mode those will be recorded to the data recording media. The recorded data's size will be displayed in the information for the SD card being recorded to. Please take note of it.

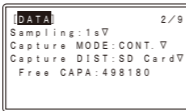

Table for DATA recording condition setting: Sampling, Capture MODE, Capture DIST.

(4) TRIGGER setting

Select the conditions for beginning data recording after measurement starts. Off: Pressing the [START/STOP] key on this module will start/stop recording. Start: The recording will start with the trigger source conditions after pressing the [START/STOP] key. The recording will stop after pressing the [START/STOP] key. Stop: The recording will start after pressing the [START/STOP] key and will be stopped with the trigger source conditions.

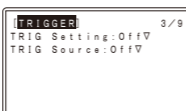
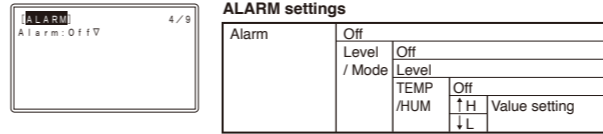

Table for TRIGGER capture condition settings: TRIG setting, TRIG Source, Alarm, Date, Time.

(5) ALARM setting

Set the alarm information. Please set the number level.



(6) Temperature Unit Setting

On the OTHER-2 screen, you can switch the temperature setting between Celsius and Fahrenheit.

3 Recording

(1) Recording

Press the [START/STOP] key to start measuring with the set conditions. After pressing [START] key, when the module is in awaiting recording start, "ARMED" is displayed, and then when recording is started, "REC" is displayed. When alarm occurs, "ALM" is displayed.

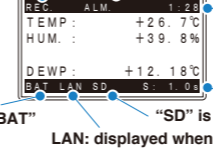

Current time Note: The current time display can be switched to the elapsed time with the [QUIT] key when recording. Sampling interval LAN: displayed when the wireless LAN connection is enabled. * You can switch to the Accumulation screen with the < and > keys when recording data.

The module's status is shown with the lamp display.

Table showing STATUS (Orange) and POWER (Green) lamp indications: Accessing SD card, Access light, Low battery, Flash once every 5 seconds, Alarm active, Flash once every 10 seconds, Power supplying, Flash once every 10 seconds, Wireless LAN connection possible status, Flash once every 5 seconds.

CAUTION When accessing an SD card, do not remove the SD card. The data may not write properly or the SD card may be damaged. When "low battery" is displayed, replace the battery or connect the USB interface to supply power as soon as possible. Caution: Batteries cannot be replaced when recording data. Replace them after the recording has finished.

(2) Recording completion

- Press the [START/STOP] key to stop measuring.
The screen display will change to the standby screen display.
Press [ENTER] key to change to the free-running screen display.



4 How To Confirm The Data

Check the recorded data with the application software included with this module using the method below (for details, refer to the USER'S MANUAL).

- (1) Connect the USB interface and check the online data
(2) Insert the SD card into PC and check the data directly
(3) Check the data directly from PC via wireless LAN

5 Specifications

Table with 2 columns: Item and Contents. Includes measurement data, system (C-MOS), temperature range (-20 to 85°C), humidity range (0.0 to 100.0% RH), response time, sampling interval, alarm settings, and dimensions.

* We recommend replacing the module periodically.

6 Combined Measurement

1. Combined temperature and humidity sensor and illumination / ultraviolet sensor measurement

Composite measurement can be done by using the branch adapter for GS (GS-DPA) and the illumination / ultraviolet sensor (GS-LXUV) (each sold separately).

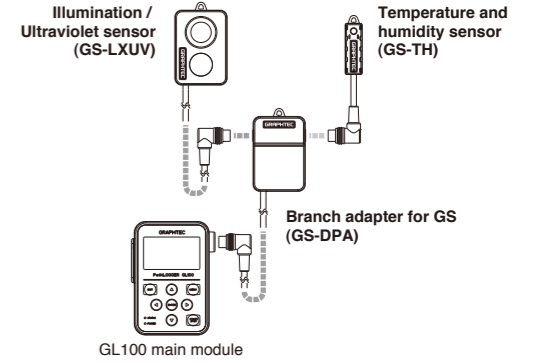

(1) Screen display menu flow

After connecting the power supply, connect this module and operate it in accordance with the content displayed on the screen.

* Refer to "2 How To Measure" above and the USER'S MANUAL for the illumination / ultraviolet sensor.

(2) Free-running screen

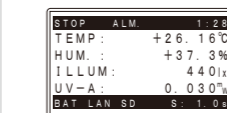

Hold down the [QUIT] key (approx. three seconds) to put the module into standby state. When running on batteries, the module will automatically go into standby state after three minutes of no operation. Press the [ENTER] key while in standby state to return to the free-running screen.

2. Combined temperature and humidity sensor and CO2 sensor measurement

Composite measurement can be done by using the branch adapter for GS (GS-DPA) and the CO2 sensor (GS-CO2) (each sold separately).

WARNING If the CO2 sensor (GS-CO2) is included in the assembly, it cannot be powered with batteries.

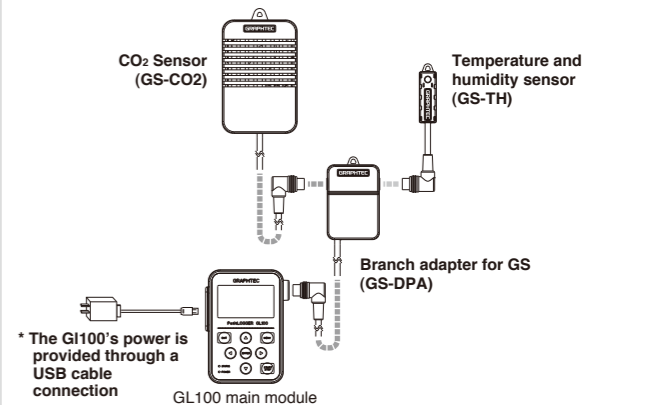

(1) Screen display menu flow

After connecting the power supply, connect this module and operate it in accordance with the content displayed on the screen.

* Refer to "2 How To Measure" above and the USER'S MANUAL for the CO2 sensor.

(2) Free-running screen

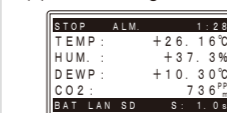

Hold down the [QUIT] key (approx. three seconds) to put the module into standby state. Press the [ENTER] key while in standby state to return to the free-running screen.

< Extension cable >

The module can be used approx. 1.5 m away from the GL100 by using an extension cable for GS (GS-EXC). However, you cannot connect and use multiple extension cables.

CAUTION It is not possible to be used by connecting two same sensors.