

Adapter for Branch adapter

USER'S MANUAL

Thank you very much for buying this GRAPHTEC product.

This module can be used as a measurement adapter (hereafter "module") that connects to the GL100-N/GL100-WL.

These directions describe preparations and cautions before measurement.

To ensure safety, please read the operation instructions, etc.

For details on the warnings and how to handle this module, please read the Quick Start Guide or USER'S MANUAL included on the CD-ROM (included in the GL100 packaging)

Confirmation of the exterior

After opening the package, please confirm that there are no problems (scratches and dirt) on the exterior before use.

Confirmation of the attached items.

- User's manual (this book): 1

If by any chance faults are found, please contact the store where you bought the item.

* Please note that items mentioned in this book may change without prior notice.

604309191

MANUAL-ADD

1 Part Names

This section describes the name and function of each part.

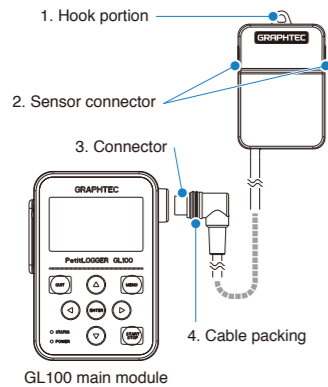

1. Wall mounting hole Used to mount to a wall.
2. Sensor connector The sensor connectors are on the left and right.
3. Connector Used to connect to the connector on the GL100 module.
4. Cable packing This packing is used when connecting the connector.

- CAUTION**
- The GL100 has basic water protection but this module has no water protection. Be careful when installing and handling.
 - Before connecting to the GL100, always connect all of the sensors to the branch adapter and then connect.
 - When using the CO₂ sensor in combination with other sensors, always use a USB cable connection as the power source.
 - The sensor connector is used for GS-LXUV, GS-CO2 or GS-TH only. Please do not connect the device other than them. The GL100-N/GL100-WL may be damaged.

< Extension cable >
The module can be used approx. 1.5 m away from the GL100 by using an extension cable for GS (GS-EXC). However, you cannot connect and use multiple extension cables.

CAUTION
It is not possible to be used by connecting two same sensors.

2 Specifications

Item	Contents
Number of connectors	2 channels
Connectable sensor	Temperature and humidity sensor (GS-TH) Illumination / ultraviolet sensor (GS-LXUV) CO ₂ sensor (GS-CO2)
Cable length	approximate 20 cm
Usage environment	-10 to 50°C, 80% RH or less (non-condensing)
External dimensions [WxDxH] (approximate)	46 x 66 x 27.4 mm (not including protruding parts)
Weight (approximate)	68 g

3 Connectable Sensor

1. Combined illumination / ultraviolet sensor and temperature and humidity sensor measurement

Composite measurement can be done by using the illumination / ultraviolet sensor (GS-LXUV) and the temperature and humidity sensor (GS-TH) (each sold separately).

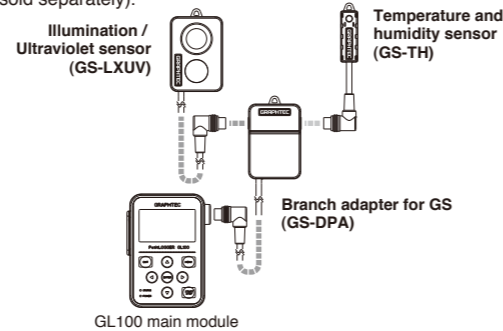

CAUTION It is not possible to be used by connecting two same sensors.

(1) Screen display menu flow

After power-on, the GL100 is ready for operation by holding down [MENU] key. When the module is connected, "Module Type Recognition" screen is displayed. When the module is not connected, "Module Unconnected State" screen is displayed.

Operate in accordance with the displayed instructions.

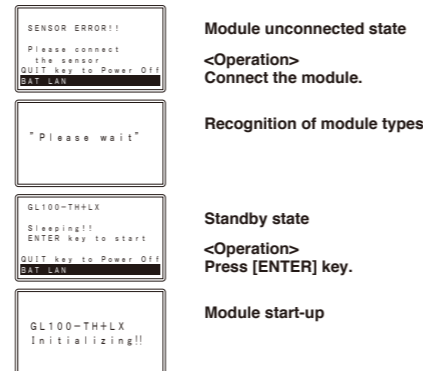

(2) Free-running screen

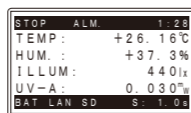

Hold down the [QUIT] key (approx. three seconds) to put the module into standby state. When running on batteries, the module will automatically go into standby state after three minutes of no operation. Press the [ENTER] key while in standby state to return to the free-running screen.

(3) Setting

AMP settings can be set in this combination.

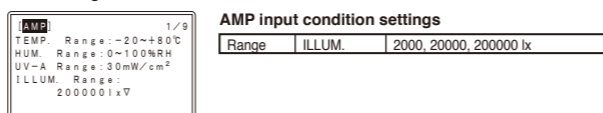

For other settings, refer to USER'S MANUAL of each module.

(4) Recording

Press the [START/STOP] key to start measuring with the set conditions. Measurements of three sensors are displayed in the screen. You can switch to the Accumulation screen with the < and > keys when recording data.

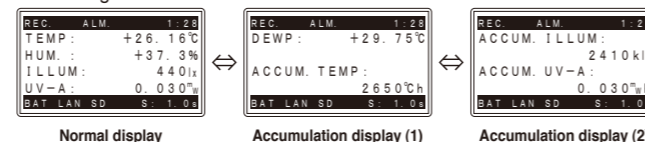

2. Combined CO₂ sensor and temperature and humidity sensor measurement

Composite measurement can be done by using the CO₂ sensor (GS-CO2) and the temperature and humidity sensor (GS-TH) (each sold separately).

WARNING If the CO₂ sensor (GS-CO2) is included in the assembly, it cannot be powered with batteries.

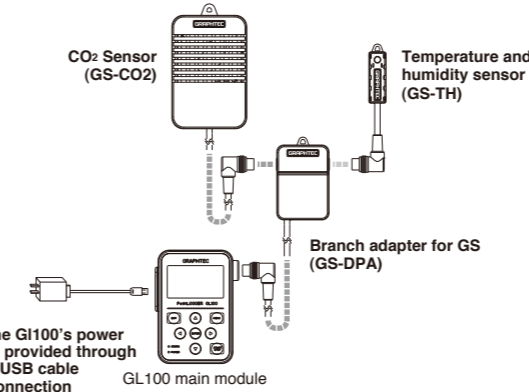

* The GL100's power is provided through a USB cable connection

CAUTION It is not possible to be used by connecting two same sensors.

(1) Screen display menu flow

After power-on, the GL100 is ready for operation by holding down [MENU] key. When the module is connected, "Module Type Recognition" screen is displayed. When the module is not connected, "Module Unconnected State" screen is displayed.

Operate in accordance with the displayed instructions.

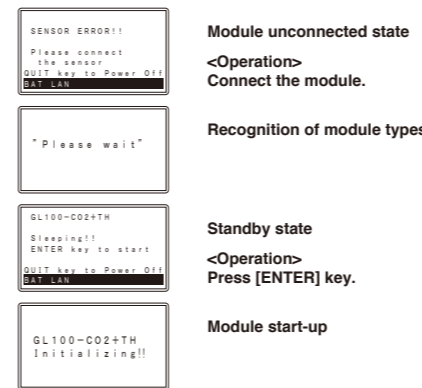

(2) Free-running screen

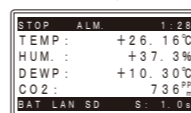

Hold down the [QUIT] key (approx. three seconds) to put the module into standby state. Press the [ENTER] key while in standby state to return to the free-running screen.

(3) Setting

For the settings, refer to USER'S MANUAL of each module.

(4) Recording

Press the [START/STOP] key to start measuring with the set conditions. Measurements of two sensors are displayed in the screen. You can switch to the Accumulation screen with the < and > keys when recording data.

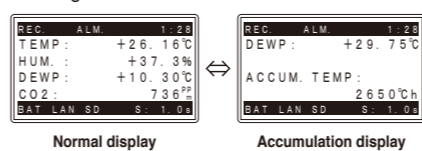

3. Combined CO₂ sensor and illumination / ultraviolet sensor

Composite measurement can be done by using the CO₂ sensor (GS-CO2) and the illumination / ultraviolet sensor (GS-LXUV) (each sold separately).

WARNING If the CO₂ sensor (GS-CO2) is included in the assembly, it cannot be powered with batteries.

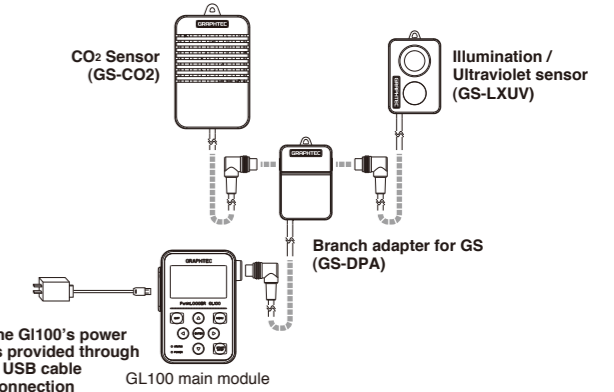

* The GL100's power is provided through a USB cable connection

CAUTION It is not possible to be used by connecting two same sensors.

(1) Screen display menu flow

After power-on, the GL100 is ready for operation by holding down [MENU] key. When the module is connected, "Module Type Recognition" screen is displayed. When the module is not connected, "Module Unconnected State" screen is displayed.

Operate in accordance with the displayed instructions.

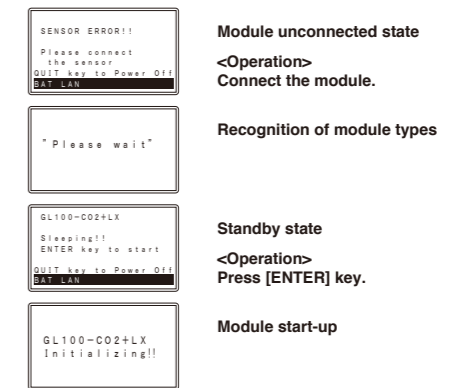

(2) Free-running screen

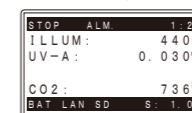

Hold down the [QUIT] key (approx. three seconds) to put the module into standby state. Press the [ENTER] key while in standby state to return to the free-running screen.

(3) Setting

AMP settings can be set in this combination.

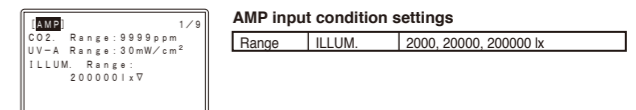

For other settings, refer to USER'S MANUAL of each module.

(4) Recording

Press the [START/STOP] key to start measuring with the set conditions. Measurements of two sensors are displayed in the screen. You can switch to the Accumulation screen with the < and > keys when recording data.

