

## OR8/R8

### Optocoupler/Relay cards

#### Connect digital signals. Quite simple.

The optocoupler and relay boards OR8 and R8 are ideal to monitor and control digital states. The digital inputs and outputs can be connected directly via a screw-clamp connection.

#### 8 optocoupler inputs (OR8). 8 relay outputs (OR8, R8).

The eight optocouplers on the OR8 convert digital inputs in the voltage range of 5..30V into TTL signals. Via relays, the OR8 and R8 switch eight control lines (TTL) with up to 6A.

#### Clearly safe.

Due to the galvanic isolation of the channels from each other and from the data acquisition and control system, the whole system is perfectly protected.

#### Current states.

Eight LEDs each dedicated to the inputs and outputs signalize if a channel is high or low.



OR8

#### Well supplied.

The R8 is operated with 5V. The OR8 is powered with 9-40V but can also be configured to 5V supply. The supply voltage is also connected via screw-clamp terminals.

#### DIN rail mounting.

The optocoupler and relay boards are suitable for DIN rail mounting. A DIN rail carrier (ZU-EW) with bracket is already included with the delivery of the OR8. It can be ordered as accessory for the R8.

#### Compatibility.

Particularly simple is the connection to the digital I/O interface USB-PIO as only a 25-pin D-Sub extension cable is needed for connecting.

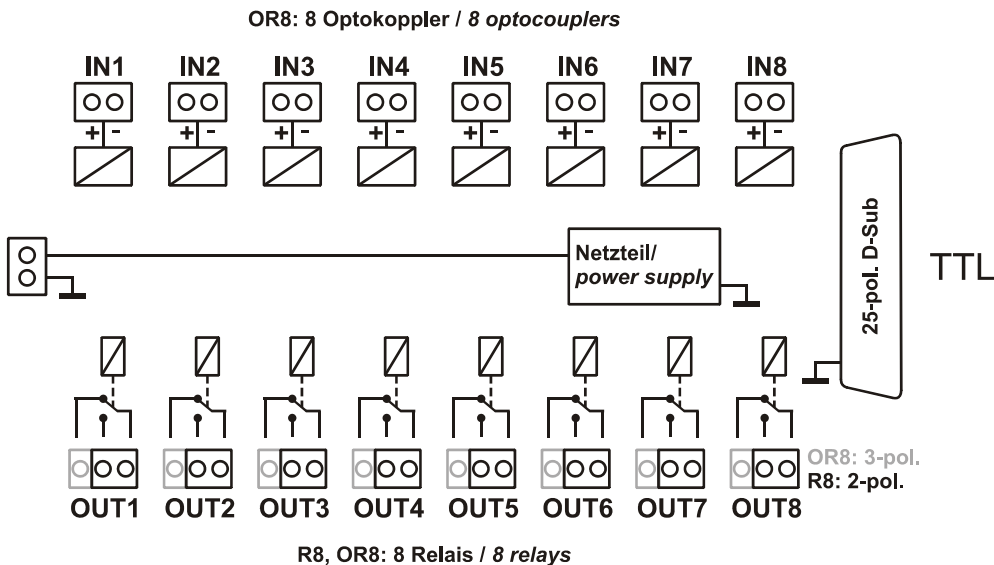

Functional diagram

# 1 Connections and pin assignments

The available connections and different components of the R8 and OR8 boards are shown in the following figure of the board (view on top of the board (fitted with components), Sub-D connector on the right).

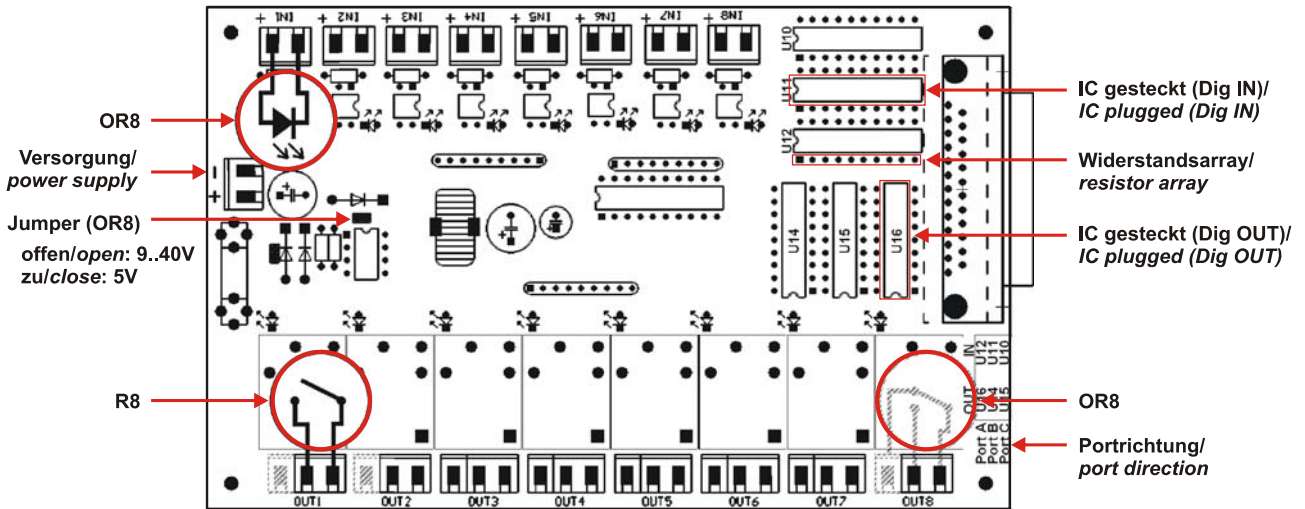

## 1.1 Power supply

The R8 is supplied with 5V DC at the screw-clamp terminal, the OR8 can be operated with 9..40V as well as with 5V (factory setting: 9..45V, jumper open).

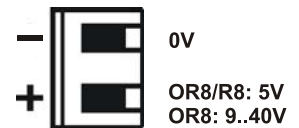

## 1.2 Optocouplers (OR8)

Connect the signal source (5..30V DC) to the screw terminals IN1..IN8. The resulting output signal (TTL) is now available at the 25-pin Sub-D male connector.



- Please carefully observe the polarity! Only apply voltages within the adjusted range!
- It is very important to turn the direction of the port packages to input, when connecting the OR8 to the USB-PIO! Otherwise the cards might be damaged!

## 1.3 Relays (OR8, R8)

The responding of the relays OUT1..OUT8 depends on the applied input level (TTL) at the 25-pin Sub-D male connector.

The R8 provides one-way switches with 2-pin terminals for the relays, whereas the OR8 is equipped with two-way switches, realized as 3-pin terminals. Therefore the circuit is always closed at one of the upper two contacts (see figure on the right).

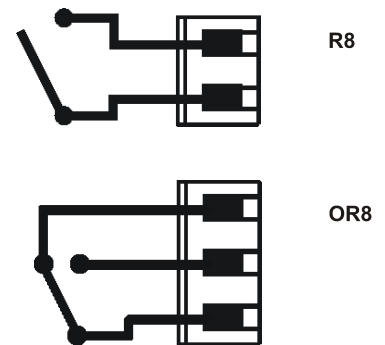

**Do not apply any voltages higher than 60V at the relay contacts! Max. current: 6A.**

## 1.4 Digital lines

### 1.4.1 OR8

As delivered, the OR8 is configured as follows:

- port A (bit 0..7) = outputs (relays 1..8)
- port B (bit 0..7) = inputs (optocouplers 1..8)

Pin assignment and direction of the digital lines at the D-Sub25 male connector of the OR8 can be defined by the user. This is done by two ICs plugged on the corresponding sockets U10-U12 (for optocoupler inputs) and U14-U16 (for relay outputs).

That means that if connecting more than 8 digital lines, port C of a USB-PIO can be used in this case for example.

A resistor array can be plugged on the input side (U10-U12) to pull the them to low allowing for the inputs to have a defined state even if no signal is applied (see table on page 4).

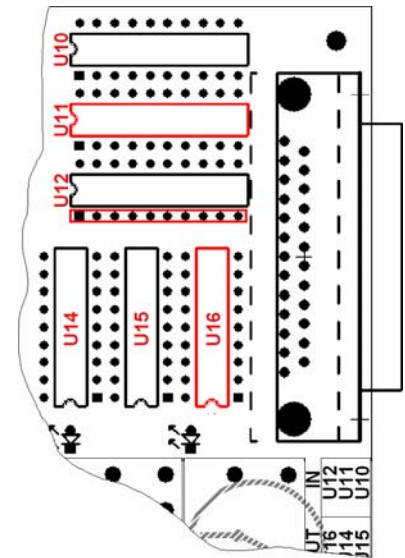

- Of course, only use one socket each for the inputs and for the outputs!
- Please note, that the port direction set for the digital measuring system must comply with the settings on the OR8, as otherwise the board might be damaged.

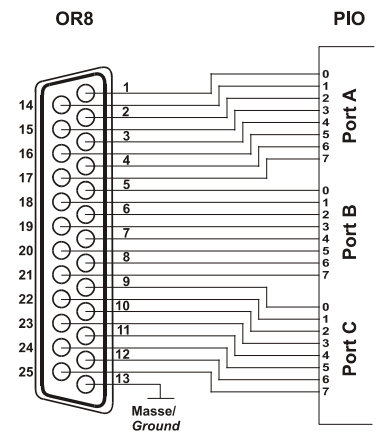

The settings are specified in the following table and figure on the right. The default setting is marked.

Pin	D-Sub25		IC on socket (Dig IN)			IC on socket (Dig OUT)			
	USB-PIO	OR8	U10	U11	U12	U14	U15	U16	Array
1	A/0	channel 1			IN1			OUT1	U12 (pin 1-10)
14	A/1	channel 2			IN2			OUT2	
2	A/2	channel 3			IN3			OUT3	
15	A/3	channel 4			IN4			OUT4	
3	A/4	channel 5			IN5			OUT5	
16	A/5	channel 6			IN6			OUT6	
4	A/6	channel 7			IN7			OUT7	
17	A/7	channel 8			IN8			OUT8	
5	B/0	channel 9		IN1		OUT1			U11 (pin 1-10)
18	B/1	channel 10		IN2		OUT2			
6	B/2	channel 11		IN3		OUT3			
19	B/3	channel 12		IN4		OUT4			
7	B/4	channel 13		IN5		OUT5			
20	B/5	channel 14		IN6		OUT6			
8	B/6	channel 15		IN7		OUT7			
21	B/7	channel 16		IN8		OUT8			
9	C/0	channel 17	IN1				OUT1		U10 (pin 1-10)
22	C/1	channel 18	IN2				OUT2		
10	C/2	channel 19	IN3				OUT3		
23	C/3	channel 20	IN4				OUT4		
11	C/4	channel 21	IN5				OUT5		
24	C/5	channel 22	IN6				OUT6		
12	C/6	channel 23	IN7				OUT7		
25	C/7	channel 24	IN8				OUT8		
13	GND	GND							

### 1.4.2 R8

Pin assignment and direction of the digital lines at the 25-pin D-Sub male connector of the R8 are hard-wired. The control lines (TTL) for the individual relay output channels OUT 1..OUT8 of an R8 have to be applied to channels 1-8.

D-Sub25	Assignment	R8	USB-PIO (Port/Bit)
1	channel 1	OUT1	A/0
14	channel 2	OUT2	A/1
2	channel 3	OUT3	A/2
15	channel 4	OUT4	A/3
3	channel 5	OUT5	A/4
16	channel 6	OUT6	A/5
4	channel 7	OUT7	A/6
17	channel 8	OUT8	A/7

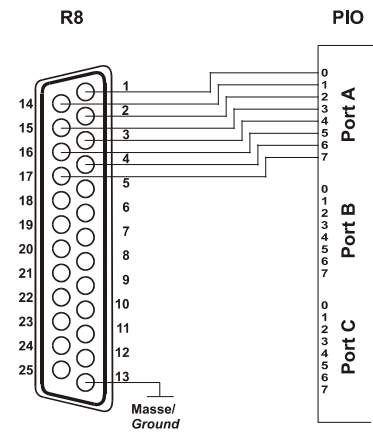

**If using a digital I/O system from bmcm (e.g. USB-PIO) connected 1:1 to the R8, port A of the USB-PIO must be set to input.**

## 2 Important notes for using the OR8/R8

- The OR8 and the R8 are only suitable for extra-low voltages – please observe the relevant regulations!
- An electrically isolated power unit (with CE) must be used for power supply.
- All accessible pins are electrostatic sensitive devices. Provide for an earthed conductive work place when installing.
- Only use non-solvent detergents for cleaning. The product is designed to be maintenance-free.
- The board must not be used for safety-relevant tasks. With the use of the product, the customer becomes manufacturer by law and is therefore fully responsible for the proper installation and use of the product. In the case of improper use and/or unauthorized interference, our warranty ceases and any warranty claim is excluded.



Do not dispose of the product in the domestic waste or at any waste collection places. It has to be either duly disposed according to the WEEE directive or can be returned to bmcm at your own expense.

## 3 Technical data (typical at 20°C, after 5min., +5V supply)

### • Electrical data

Power supply (OR8):	9..40V DC (ex works, solder jumper open) or +5V DC (solder jumper closed), ±5%, max. 4W
Power supply (R8):	+5V DC, ±5%, max. 0.7A DC, max. 3.5W
Input voltage:	5..30V
Input current (OR8):	max. 17mA; response time of the optocouplers <1ms
Relay data (OR8, R8):	max. current: 6A DC; response time: 10ms; live period: 100000 cycles

### • General data

Temperature range:	operating temp. 0..70°C, storage temp. -25..70°C
Relative humidity:	0-90% (not condensing)
CE standards:	EN61000-6-1, EN61000-6-3, EN61010-1; for decl. of conformity (PDF) visit <a href="http://www.bmcm.de">www.bmcm.de</a>
ElektroG // ear registration:	RoHS and WEEE compliant // WEEE Reg.-No. DE75472248
Dimensions (L x W x H):	OR8: 167mm x 105mm x 33mm; R8: 160mm x 100mm x 20mm
Available accessories (optional):	DIN rail set ZU-EW (OR8: included with delivery), connecting cable ZUKA25, waterproof housing ZU-PBOX-PG, ZU-PBOX-LAN
Warranty:	2 years from date of purchase at bmcm, claims for damages resulting from improper use excluded